

Spectral analysis on singular spaces

Alexander Teplyaev
University of Connecticut



Analysis and Geometry on Graphs and Manifolds

Potsdam 2017

abstract:

The talk will outline recent achievements and challenges in spectral and stochastic analysis on non-smooth spaces that are very singular, but can be approximated by graphs or manifolds. In particular, the talk will present two of most interesting examples that are currently under investigation. One example deals with the spectral analysis of the Laplacian on the famous basilica Julia set, the Julia set of the polynomial $z^2 - 1$. This is a joint work with Luke Rogers and several students at UConn. The other example deals with spectral analysis for the canonical diffusion on the pattern spaces of an aperiodic Delone set. This is a joint work with Patricia Alonso-Ruiz, Michael Hinz and Rodrigo Trevino.

outline:

- – Introduction and motivation.
- 1. Bohr asymptotics on infinite Sierpinski gasket (with Joe Chen, Stanislav Molchanov, 2015). Singularly continuous spectrum of a self-similar Laplacian on the half-line (with Joe Chen, 2016).
- 2. Spectrum of the Laplacian on the Basilica Julia set (with Toni Brzoska, Luke Rogers et al. (research in progress)).
- 3. Canonical diffusions on the pattern spaces of aperiodic Delone sets (with Patricia Alonso-Ruiz, Michael Hinz, Rodrigo Treviño (research in progress)).

This is a part of the broader program to develop **spectral and vector analysis on singular spaces** by **carefully building approximations by graphs or manifolds.**

Asymptotic aspects of Schreier graphs and Hanoi Towers groups

Rostislav Grigorchuk¹, Zoran Šunić

Department of Mathematics, Texas A&M University, MS-3368, College Station, TX, 77843-3368, USA

Received 23 January, 2006; accepted after revision +++++

Presented by Étienne Ghys

Abstract

We present relations between growth, growth of diameters and the rate of vanishing of the spectral gap in Schreier graphs of automaton groups. In particular, we introduce a series of examples, called Hanoi Towers groups since they model the well known Hanoi Towers Problem, that illustrate some of the possible types of behavior. *To cite this article:* R. Grigorchuk, Z. Šunić, *C. R. Acad. Sci. Paris, Ser. I* 344 (2006).

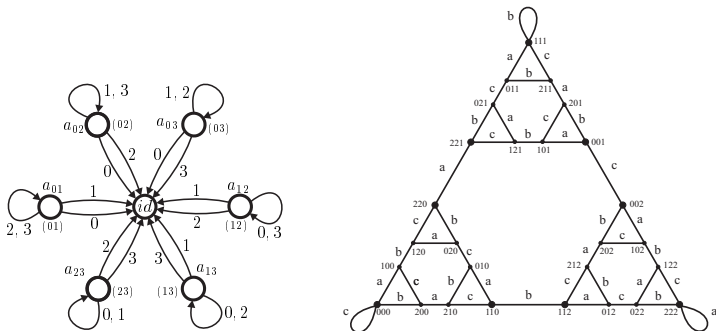
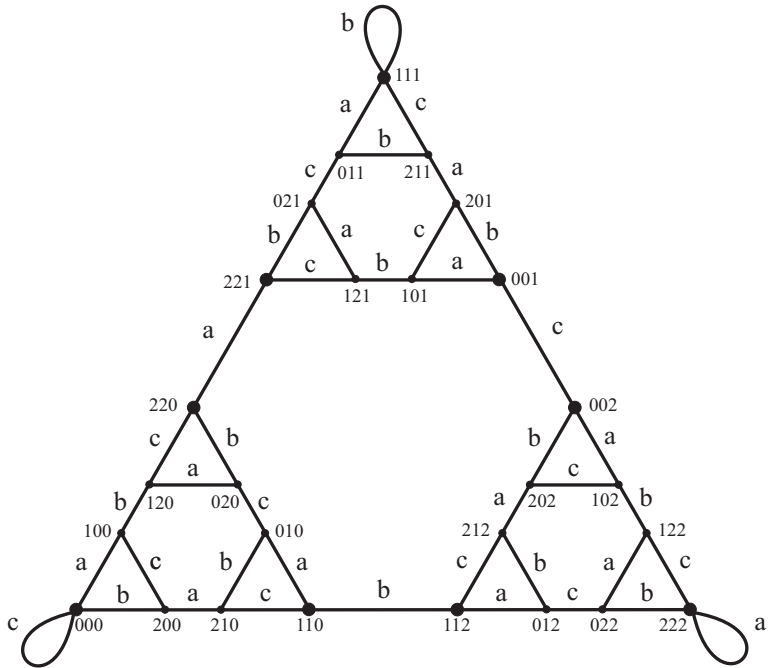

Figure 1. The automaton generating $H^{(4)}$ and the Schreier graph of $H^{(3)}$ at level 3 / L'automate engendrant $H^{(4)}$ et le graphe de Schreier de $H^{(3)}$ au niveau 3



Energy spectrum for a fractal lattice in a magnetic field

Jayanth R. Banavar

Schlumberger-Doll Research, Old Quarry Road, Ridgefield, Connecticut 06877-4108

Leo Kadanoff

Department of Physics, University of Chicago, Chicago, Illinois 60637

A. M. M. Pruisken*

Schlumberger-Doll Research, Old Quarry Road, Ridgefield, Connecticut 06877-4108

(Received 10 September 1984)

To simulate a kind of magnetic field in a fractal environment we study the tight-binding Schrödinger equation on a Sierpinski gasket. The magnetic field is represented by the introduction of a phase onto each hopping matrix element. The energy levels can then be determined by either direct diagonalization or recursive methods. The introduction of a phase breaks all the degeneracies which exist in and dominate the zero-field solution. The spectrum in the field may be viewed as considerably broader than the spectrum with no field. A novel feature of the recursion relations is that it leads to a power-law behavior of the escape rate. Green's-function arguments suggest that a majority of the eigenstates are truly extended despite the finite order of ramification of the fractal lattice.

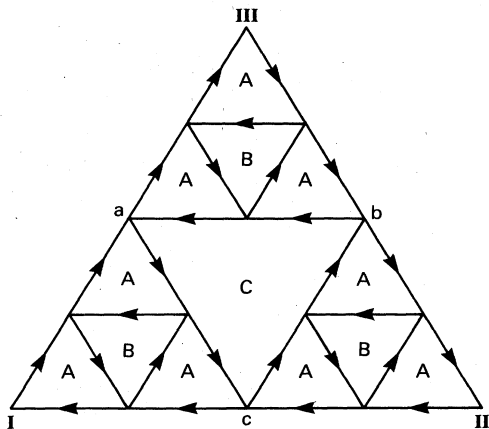

FIG. 1. Fragment of the Sierpinski gasket. The phase of the hopping matrix is equal to ϕ in the direction of the arrow and $-\phi$ otherwise.

BAND SPECTRUM FOR AN ELECTRON ON A SIERPINSKI GASKET IN A MAGNETIC FIELD

J.M. Ghez*

Centre de Physique Théorique, CNRS-Luminy, Case 907, F-13288, Marseille, Cedex 09, France

and

Yin Yu Wang, R. Rammal† and B. Pannetier

CRTBT, CNRS, BP 166X, Grenoble Cedex, France

and

J. Bellissard‡

Centre de Physique Théorique, CNRS-Luminy, Case 907, F-13288, Marseille, Cedex 09, France

(Received 20 July 1987 by S. Alexander)

We consider a quantum charged particle on a fractal lattice given by a Sierpinski gasket, submitted to a uniform magnetic field, in a tight binding approximation. Its band spectrum is numerically computed and exhibits a fractal structure. The groundstate energy is also compared to the superconductor transition curve measured for a Sierpinski lattice of superconducting material.

choose the gauge in such a way that H depends only upon α and α' in a periodic way with period one. We will denote by $H(\alpha, \alpha')$ this operator from now on.

We also introduce the dilation operator D defined as:

$$D\varphi(m) = \varphi(2m). \quad (2)$$

The scaling properties of this system are expressed in the following Renormalization Group Equation (RGE) [23]:

$$E\{E1 - H(\alpha, \alpha')\}^{-1}D = G\{E^*1 - H(\alpha^*, \alpha'^*)\}^{-1}, \quad (3)$$

where [7, 16]:

$$(i) \quad G = \frac{\{E^3 - 3E - 2(XU + YV)\}}{(S^2 + C^2)^{1/2}},$$

$$(ii) \quad E^* = \frac{\{E^4 - 7E^2 - [2(XU + YV) + 4X]E + 4(1 - U)\}}{(S^2 + C^2)^{1/2}}, \quad (4)$$

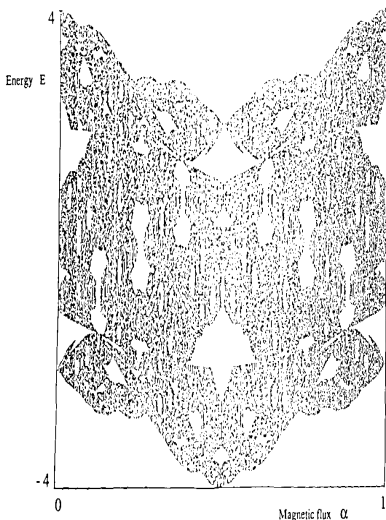

Fig. 2. Spectrum of $H(\alpha)$, computed by 10 iterations of F . α is the horizontal variable, ranging from 0 to 1. E is the vertical variable, ranging from -4 to 4 .

These results have been compared with an experiment performed on an array of superconducting Al-wires shaped like a Sierpinski gasket with six levels of hierarchy. A description of this pattern generated by e-beam lithography has been given in [20]. More details will be published in a separate paper [21]. The transition curve in the parameter space (T, B) , where

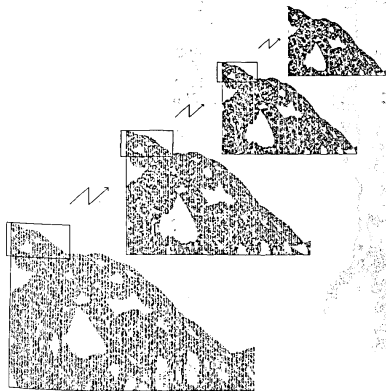

Fig. 3. Four enlargements of the upper left corner of Fig. 2, showing the fractal nature of the spectrum, with the approximate scaling law (7). α is the horizontal variable, ranging from 0 to 2^{-k} , $k = 2, 4, 6, 8$. E is the vertical variable, ranging from E_0 to 4, $E_0 = 2.4, 3.68, 3.936, 3.9872$.

observes experimentally the periodicity in the parameter α and also the scaling properties predicted by the RGE (equation 3). The plot in Fig. 4 shows the comparison between the experimental curve in log-log scale together with the theoretical results for the edge

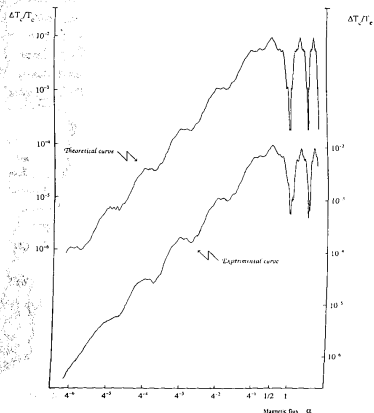

Fig. 4. Comparison between the calculated edge of the spectrum (left scale) with the experimental result (right scale) on the critical temperature of a superconducting gasket: $\Delta T_c / T_c$ vs α in log-log plot, where $\alpha = \Phi / \Phi_0$ is the reduced magnetic flux in the elementary triangle of the gasket: equation 8 has been used to calculate the theoretical curve using the best fit parameters as explained in the text. The two curves have been shifted for clarity.

François Englert

From Wikipedia, the free encyclopedia

François Baron Englert (French: [ɑ̃ɡlɛʁ]; born 6 November 1932) is a Belgian theoretical physicist and 2013 Nobel prize laureate (shared with Peter Higgs). He is Professor emeritus at the Université libre de Bruxelles (ULB) where he is member of the Service de Physique Théorique. He is also a Sackler Professor by Special Appointment in the School of Physics and Astronomy at Tel Aviv University and a member of the Institute for Quantum Studies at Chapman University in California. He was awarded the 2010 J. J. Sakurai Prize for Theoretical Particle Physics (with Gerry Guralnik, C. R. Hagen, Tom Kibble, Peter Higgs, and Robert Brout), the Wolf Prize in Physics in 2004 (with Brout and Higgs) and the High Energy and Particle Prize of the European Physical Society (with Brout and Higgs) in 1997 for the mechanism which unifies short and long range interactions by generating massive gauge vector bosons. He has made contributions in statistical physics, quantum field theory, cosmology, string theory and supergravity.^[4] He is the recipient of the 2013 Prince of Asturias Award in technical and scientific research, together with Peter Higgs and the CERN

François Englert

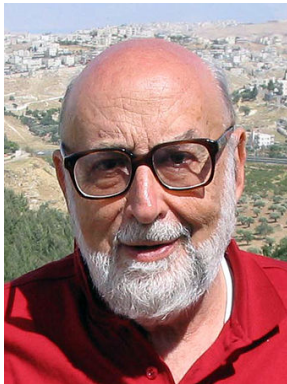

François Englert in Israel, 2007

**METRIC SPACE-TIME AS FIXED POINT
OF THE RENORMALIZATION GROUP EQUATIONS
ON FRACTAL STRUCTURES**

F. ENGLERT, J.-M. FRÈRE¹ and M. ROOMAN²

Physique Théorique, C.P. 225, Université Libre de Bruxelles, 1050 Brussels, Belgium

Ph. SPINDEL

Faculté des Sciences, Université de l'Etat à Mons, 7000 Mons, Belgium

Received 19 February 1986

We take a model of foamy space-time structure described by self-similar fractals. We study the propagation of a scalar field on such a background and we show that for almost any initial conditions the renormalization group equations lead to an effective highly symmetric metric at large scale.

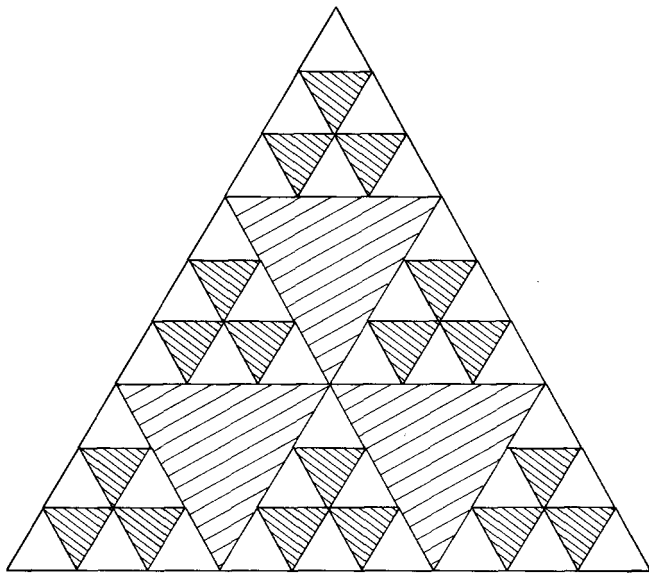

Fig. 1. The first two iterations of a 2-dimensional 3-fractal.

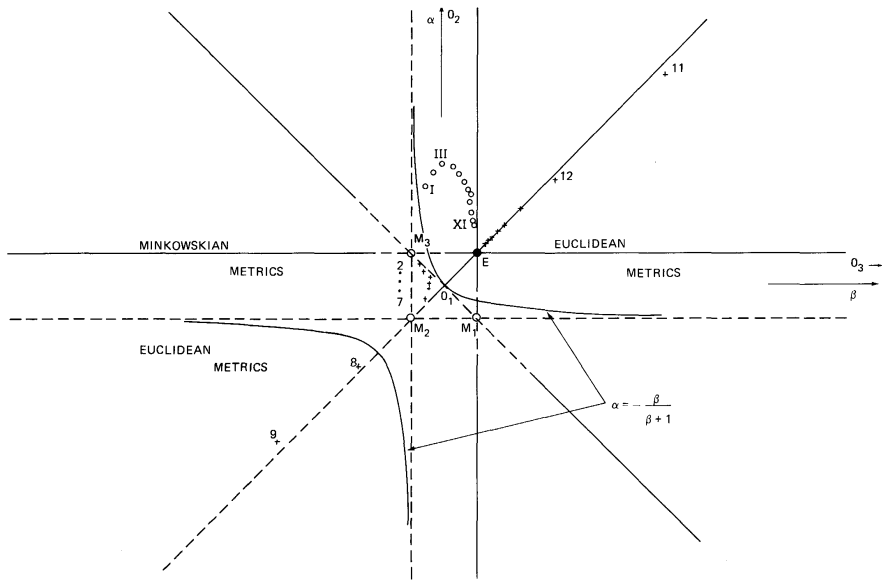

Fig. 5. The plane of 2-parameter homogeneous metrics on the Sierpinski gasket. The hyperbola $\alpha = -\beta/(\beta + 1)$ separates the domain of euclidean metrics from minkowskian metrics and corresponds - except at the origin - to 1-dimensional metrics. M_1, M_2, M_3 denote unstable minkowskian fixed geometries while E corresponds to the stable euclidean fixed point. The unstable fixed points $0_1, 0_2$ and 0_3 associated to 0-dimensional geometries are located at the origin and at infinity on the (α, β) coordinates axis. The six straight lines are subsets invariant with respect to the recursion relation but repulsive in the region where they are dashed. The first points of two sequences of iterations are drawn. Note that for one of them the 10th point ($\alpha = -56.4, \beta = -52.5$) is outside the frame of the figure.

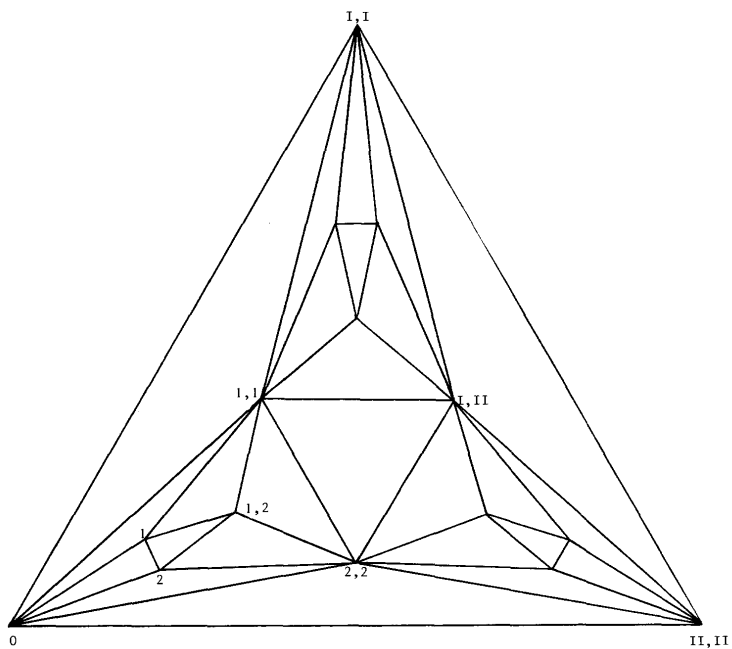

Fig. 10. A metrical representation of the two first iterations of a 2-dimensional 2-fractal corresponding to the euclidean fixed point. Vertices are labelled according to fig. 4.

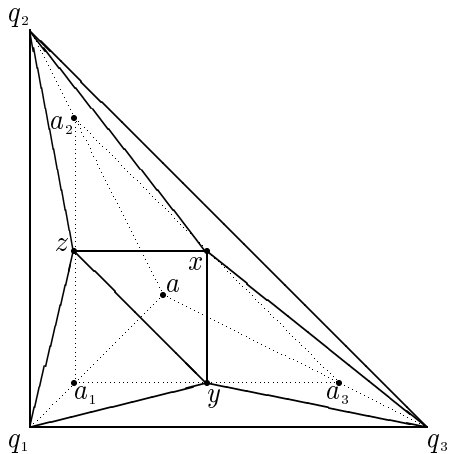

Figure 6.4. Geometric interpretation of Proposition 6.1.

The Spectral Dimension of the Universe is Scale Dependent

J. Ambjørn,^{1,3,*} J. Jurkiewicz,^{2,†} and R. Loll^{3,‡}

¹The Niels Bohr Institute, Copenhagen University, Blegdamsvej 17, DK-2100 Copenhagen Ø, Denmark

²Mark Kac Complex Systems Research Centre, Marian Smoluchowski Institute of Physics, Jagellonian University, Reymonta 4, PL 30-059 Krakow, Poland

³Institute for Theoretical Physics, Utrecht University, Leuvenlaan 4, NL-3584 CE Utrecht, The Netherlands

(Received 13 May 2005; published 20 October 2005)

We measure the spectral dimension of universes emerging from nonperturbative quantum gravity, defined through state sums of causal triangulated geometries. While four dimensional on large scales, the quantum universe appears two dimensional at short distances. We conclude that quantum gravity may be “self-renormalizing” at the Planck scale, by virtue of a mechanism of dynamical dimensional reduction.

DOI: 10.1103/PhysRevLett.95.171301

PACS numbers: 04.60.Gw, 04.60.Nc, 98.80.Qc

Quantum gravity as an ultraviolet regulator?—A shared hope of researchers in otherwise disparate approaches to quantum gravity is that the microstructure of space and time may provide a physical regulator for the ultraviolet infinities encountered in perturbative quantum field theory.

tral dimension, a diffeomorphism-invariant quantity obtained from studying diffusion on the quantum ensemble of geometries. On large scales and within measuring accuracy, it is equal to four, in agreement with earlier measurements of the large-scale dimensionality based on the

other hand, the “short-distance spectral dimension,” obtained by extrapolating Eq. (12) to $\sigma \rightarrow 0$ is given by

$$D_S(\sigma = 0) = 1.80 \pm 0.25, \quad (15)$$

and thus is compatible with the integer value two.

Fractal space-times under the microscope: A Renormalization Group view on Monte Carlo data

Martin Reuter and Frank Saueressig

*Institute of Physics, University of Mainz
Staudingerweg 7, D-55099 Mainz, Germany*

reuter@thep.physik.uni-mainz.de
saueressig@thep.physik.uni-mainz.de

Abstract

The emergence of fractal features in the microscopic structure of space-time is a common theme in many approaches to quantum gravity. In this work we carry out a detailed renormalization group study of the spectral dimension d_s and walk dimension d_w associated with the effective space-times of asymptotically safe Quantum Einstein Gravity (QEG). We discover three scaling regimes where these generalized dimensions are approximately constant for an extended range of length scales: a classical regime where $d_s = d, d_w = 2$, a semi-classical regime where $d_s = 2d/(2+d), d_w = 2+d$, and the UV-fixed point regime where $d_s = d/2, d_w = 4$. On the length scales covered by three-dimensional Monte Carlo simulations, the resulting spectral dimension is shown to be in very good agreement with the data. This comparison also provides a natural explanation for the apparent puzzle between the short distance behavior of the spectral dimension reported from Causal Dynamical Triangulations (CDT), Euclidean Dynamical Triangulations (EDT), and Asymptotic Safety.

Fractal space-times under the microscope: A Renormalization Group view on Monte Carlo data

Martin Reuter and Frank Saueressig

a classical regime where $d_s = d, d_w = 2$, a semi-classical regime where $d_s = 2d/(2 + d), d_w = 2 + d$, and the UV-fixed point regime where $d_s = d/2, d_w = 4$. On the length scales covered

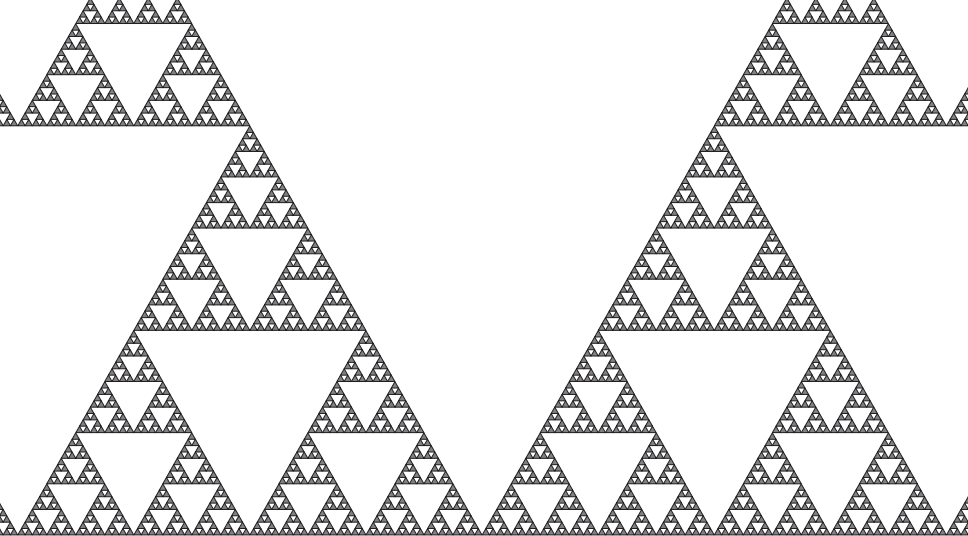

A part of an infinite Sierpiński gasket.

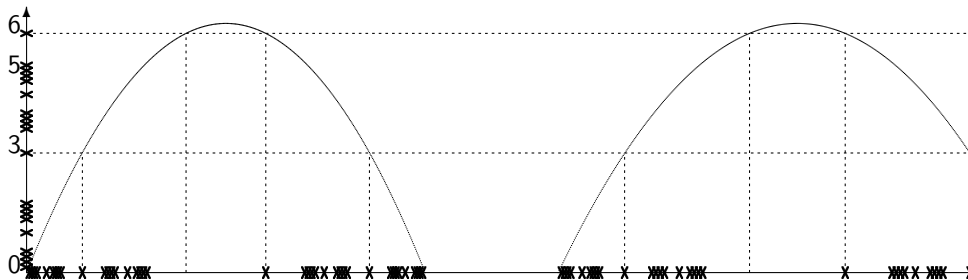

Figure: An illustration to the computation of the spectrum on the infinite Sierpiński gasket. The curved lines show the graph of the function $\mathfrak{R}(\cdot)$.

Theorem (Béllissard 1988, T. 1998, Quint 2009)

*On the infinite Sierpiński gasket the spectrum of the Laplacian consists of a **dense set of eigenvalues** $\mathfrak{R}^{-1}(\Sigma_0)$ of infinite multiplicity and a **singularly continuous component of spectral multiplicity one supported on $\mathfrak{R}^{-1}(\mathcal{J}_R)$.***

Half-line example

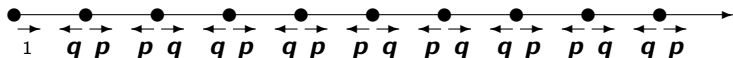

Figure: Transition probabilities in the pq random walk. Here $p \in (0, 1)$ and $q = 1 - p$.

$$(\Delta_p f)(x) = \begin{cases} f(0) - f(1), & \text{if } x = 0 \\ f(x) - qf(x-1) - pf(x+1), & \text{if } 3^{-m(x)}x \equiv 1 \pmod{3} \\ f(x) - pf(x-1) - qf(x+1), & \text{if } 3^{-m(x)}x \equiv 2 \pmod{3} \end{cases}$$

Theorem (J.P.Chen, T., 2016)

If $p \neq \frac{1}{2}$, the Laplacian Δ_p on $\ell^2(\mathbb{Z}_+)$ has **purely singularly continuous spectrum**.

The spectrum is the Julia set of the polynomial $R(z) = \frac{z(z^2 - 3z + (2 + pq))}{pq}$, which is a **topological Cantor set of Lebesgue measure zero**.

Bohr asymptotics

For 1D Schrödinger operator

$$H\psi = -\psi'' + V(x)\psi, \quad x \geq 0 \quad (1)$$

if $V(x) \rightarrow +\infty$ as $x \rightarrow +\infty$ then (H. Weyl), the spectrum of H in $L^2([0, \infty), dx)$ is discrete and, under some technical conditions,

$$N(\lambda, V) := \#\{\lambda_i(H) \leq \lambda\} \sim \frac{1}{\pi} \int_0^\infty \sqrt{(\lambda - V(x))_+} dx. \quad (2)$$

This is known as the Bohr's formula. It can be generalized for \mathbb{R}^n .

Theorem (Fractal Bohr's formula (Joe Chen, Stanislav Molchanov, T., J. Phys. A: Math. Theor. (2015)))

On infinite Sierpinski-type fractafolds, under mild assumptions,

$$\lim_{\lambda \rightarrow \infty} \frac{N(\mathbf{V}, \lambda)}{g(\mathbf{V}, \lambda)} = 1, \quad (3)$$

where

$$g(\mathbf{V}, \lambda) := \int_{K_\infty} [(\lambda - \mathbf{V}(x))_+]^{d_s/2} \mathbf{G} \left(\frac{1}{2} \log(\lambda - \mathbf{V}(x))_+ \right) \mu_\infty(dx), \quad (4)$$

where \mathbf{G} is the Kigami-Lapidus periodic function, obtained via a renewal theorem.

Part 2: Spectral Analysis of the Basilica Graphs (with Toni Brzoska, Luke Rogers et al.)

The question of existence of groups with **intermediate growth, i.e. subexponential but not polynomial**, was asked by **Milnor in 1968** and answered in the positive by **Grigorchuk in 1984**. There are still open questions in this area, and a complete picture of which orders of growth are possible, and which are not, is missing.

The Basilica group is a group generated by a finite automaton acting on the binary tree in a self-similar fashion, introduced by **R. Grigorchuk and A. Zuk in 2002**, does not belong to the closure of the set of groups of subexponential growth under the operations of group extension and direct limit.

In 2005 **L. Bartholdi and B. Virag** further showed it to be amenable, making the Basilica group the **1st example of an amenable but not subexponentially amenable group** (also “Münchhausen trick” and amenability of self-similar groups by **V.A. Kaimanovich**).

Part 2: Spectral Analysis of the Basilica Graphs (with Toni Brzoska, Luke Rogers et al.)

The question of existence of groups with **intermediate growth, i.e. subexponential but not polynomial**, was asked by **Milnor in 1968** and answered in the positive by **Grigorchuk in 1984**. There are still open questions in this area, and a complete picture of which orders of growth are possible, and which are not, is missing.

The Basilica group is a group generated by a finite automaton acting on the binary tree in a self-similar fashion, introduced by **R. Grigorchuk and A. Zuk in 2002**, does not belong to the closure of the set of groups of subexponential growth under the operations of group extension and direct limit.

In 2005 L. Bartholdi and B. Virag further showed it to be amenable, making the Basilica group the 1st example of an amenable but not subexponentially amenable group (also “Münchhausen trick” and amenability of self-similar groups by V.A. Kaimanovich).

Part 2: Spectral Analysis of the Basilica Graphs (with Toni Brzoska, Luke Rogers et al.)

The question of existence of groups with **intermediate growth, i.e. subexponential but not polynomial**, was asked by **Milnor in 1968** and answered in the positive by **Grigorchuk in 1984**. There are still open questions in this area, and a complete picture of which orders of growth are possible, and which are not, is missing.

The Basilica group is a group generated by a finite automaton acting on the binary tree in a self-similar fashion, introduced by **R. Grigorchuk and A. Zuk in 2002**, does not belong to the closure of the set of groups of subexponential growth under the operations of group extension and direct limit.

In 2005 L. Bartholdi and B. Virag further showed it to be amenable, making the Basilica group **the 1st example of an amenable but not subexponentially amenable group** (also “Münchhausen trick” and **amenability of self-similar groups by V.A. Kaimanovich**).

The Basilica fractal is the Julia set of the polynomial $z^2 - 1$. In 2005, V. Nekrashevych described the group as the iterated monodromy group, and there exists a natural way to associate it to the Basilica fractal (Nekrashevych+T., 2008).

In Schreier graphs of the Basilica group (2010), Nagnibeda et al. classified up to isomorphism all possible limits of finite Schreier graphs of the Basilica group.

In Laplacians on the Basilica Julia set (2010), L. Rogers+T. constructed Dirichlet forms and the corresponding Laplacians on the Basilica fractal in two different ways: by imposing a self-similar harmonic structure and a graph-directed self-similar structure on the fractal.

In Laplacians on a Family of Quadratic Julia Sets I (2012), T. Flock and R. Strichartz provided numerical techniques to approximate eigenvalues and eigenfunctions on families of Laplacians on the Julia sets of $z^2 + c$.

The Basilica fractal is the Julia set of the polynomial $z^2 - 1$. In 2005, V. Nekrashevych described the group as the iterated monodromy group, and there exists a natural way to associate it to the Basilica fractal (Nekrashevych+T., 2008).

In Schreier graphs of the Basilica group (2010), Nagnibeda et al. classified up to isomorphism all possible limits of finite Schreier graphs of the Basilica group.

In Laplacians on the Basilica Julia set (2010), L. Rogers+T. constructed Dirichlet forms and the corresponding Laplacians on the Basilica fractal in two different ways: by imposing a self-similar harmonic structure and a graph-directed self-similar structure on the fractal.

In Laplacians on a Family of Quadratic Julia Sets I (2012), T. Flock and R. Strichartz provided numerical techniques to approximate eigenvalues and eigenfunctions on families of Laplacians on the Julia sets of $z^2 + c$.

The Basilica fractal is the Julia set of the polynomial $z^2 - 1$. In 2005, V. Nekrashevych described the group as the iterated monodromy group, and there exists a natural way to associate it to the Basilica fractal (Nekrashevych+T., 2008).

In Schreier graphs of the Basilica group (2010), Nagnibeda et al. classified up to isomorphism all possible limits of finite Schreier graphs of the Basilica group.

In Laplacians on the Basilica Julia set (2010), L. Rogers+T. constructed Dirichlet forms and the corresponding Laplacians on the Basilica fractal in two different ways: by imposing a self-similar harmonic structure and a graph-directed self-similar structure on the fractal.

In Laplacians on a Family of Quadratic Julia Sets I (2012), T. Flock and R. Strichartz provided numerical techniques to approximate eigenvalues and eigenfunctions on families of Laplacians on the Julia sets of $z^2 + c$.

The Basilica fractal is the Julia set of the polynomial $z^2 - 1$. In 2005, V. Nekrashevych described the group as the iterated monodromy group, and there exists a natural way to associate it to the Basilica fractal (Nekrashevych+T., 2008).

In Schreier graphs of the Basilica group (2010), Nagnibeda et al. classified up to isomorphism all possible limits of finite Schreier graphs of the Basilica group.

In Laplacians on the Basilica Julia set (2010), L. Rogers+T. constructed Dirichlet forms and the corresponding Laplacians on the Basilica fractal in two different ways: by imposing a self-similar harmonic structure and a graph-directed self-similar structure on the fractal.

In Laplacians on a Family of Quadratic Julia Sets I (2012), T. Flock and R. Strichartz provided numerical techniques to approximate eigenvalues and eigenfunctions on families of Laplacians on the Julia sets of $z^2 + c$.

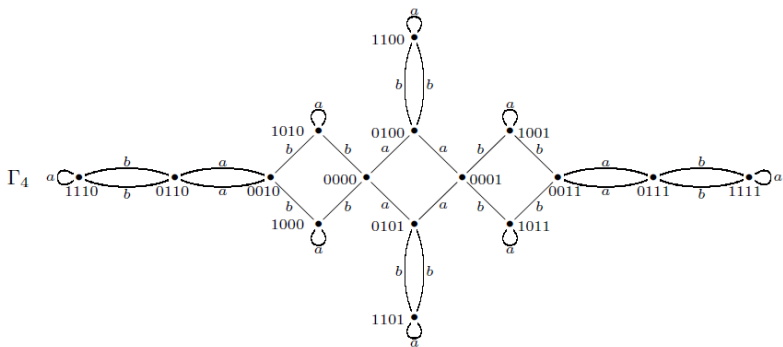
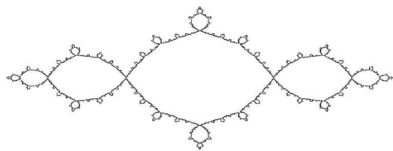

pictures taken from paper by Nagnibeda et. al.

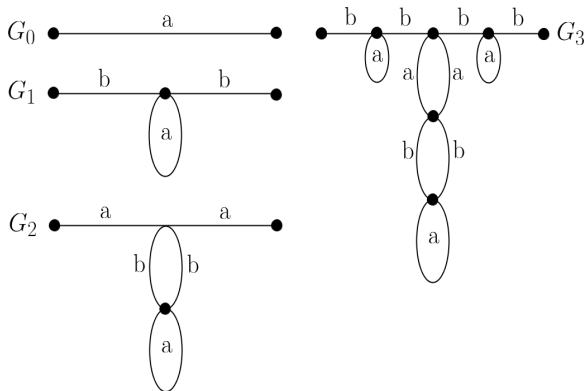
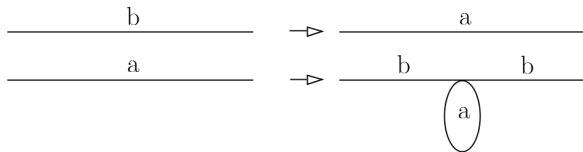
Replacement Rule and the Graphs G_n 

Distribution of Eigenvalues, Level 13 (numerics)

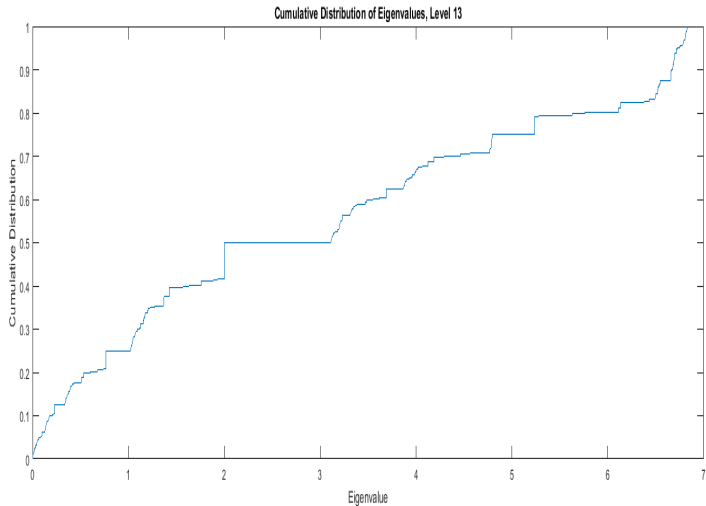

One can define a Dirichlet to Neumann map for the two boundary points of the graphs G_n . One can construct a dynamical system to determine these maps (which are two by two matrices). The dynamical system allows us to prove the following.

Theorem

In the Hausdorff metric, $\limsup_{n \rightarrow \infty} \sigma(L^{(n)})$ has a gap that contains the interval $(2.5, 2.8)$.

Conjecture

In the Hausdorff metric, $\limsup_{n \rightarrow \infty} \sigma(L^{(n)})$ has infinitely many gaps.

Proving the conjecture would be interesting. One would be able to apply the results discovered by R. Strichartz in *Laplacians on Fractals with Spectral Gaps have nicer Fourier Series* (2005).

Infinite Blow-ups of G_n

Definition

Let $\{k_n\}_{n \in \mathbb{N}}$ be a strictly increasing subsequence of the natural numbers. For each n , embed G_{k_n} in some isomorphic subgraph of $G_{k_{n+1}}$. The corresponding infinite blow-up is $G_\infty := \bigcup_{n \geq 0} G_{k_n}$.

Assumption

The infinite blow-up G_∞ satisfies:

- For $n \geq 1$, the long path of $G_{k_{n-1}}$ is embedded in a loop γ_n of G_{k_n} .
- Apart from $l_{k_{n-1}}$ and $r_{k_{n-1}}$, no vertex of the long path can be the 3, 6, 9 or 12 o'clock vertex of γ_n .
- The only vertices of G_{k_n} that connect to vertices outside the graph are the boundary vertices of G_{k_n} .

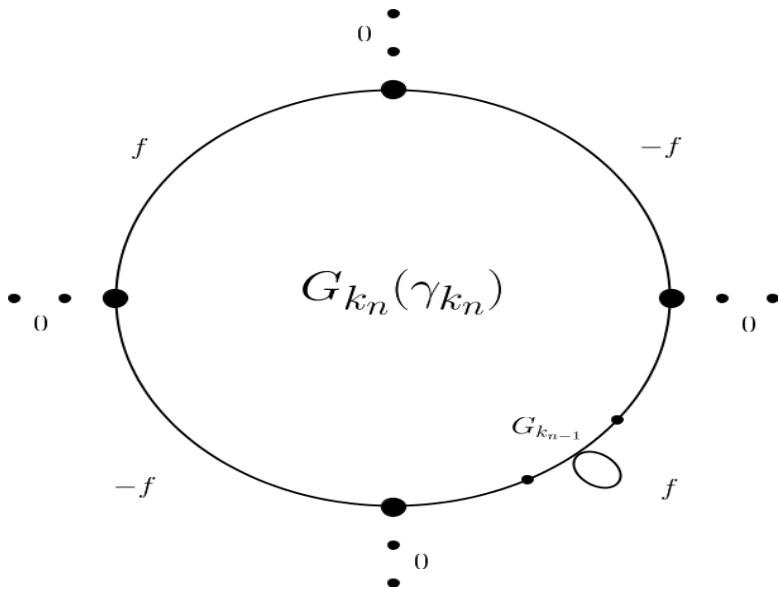

(conjectured)

Theorem

$$(1) \sigma(L^{(k_n)}|_{\ell^2_{a, k_n, \gamma_n}}) = \sigma(L_0^{(j_n)}).$$

(2) The spectrum of $L^{(\infty)}$ is pure point. The set of eigenvalues of $L^{(\infty)}$ is

$$\bigcup_{n \geq 0} \sigma(L_0^{(j_n)}) = \bigcup_{n \geq 0} c_{j_n}^{-1}\{0\},$$

where the polynomials c_n are the characteristic polynomials of $L_0^{(n)}$, as defined in the previous proposition.

(3) Moreover, the set of eigenfunctions of $L^{(\infty)}$ with finite support is complete in ℓ^2 .

Part 3: Canonical diffusions on the pattern spaces of aperiodic Delone sets (Patricia Alonso-Ruiz, Michael Hinz, T., Rodrigo Treviño)

A subset $\Lambda \subset \mathbb{R}^d$ is a *Delone set* if it is *uniformly discrete*:

$$\exists \epsilon > 0 : \forall \vec{x}, \vec{y} \in \Lambda \quad |\vec{x} - \vec{y}| > \epsilon$$

and *relatively dense*:

$$\exists R > 0 : \Lambda \cap B_R(\vec{x}) \neq \emptyset \forall \vec{x} \in \mathbb{R}^d.$$

A Delone set has *finite local complexity* if $\forall R > 0 \exists$ finitely many clusters P_1, \dots, P_{n_R} such that for any $\vec{x} \in \mathbb{R}^d$ there is an i such that the set $B_R(\vec{x}) \cap \Lambda$ is translation-equivalent to P_i .

A Delone set Λ is *aperiodic* if $\Lambda - \vec{t} = \Lambda$ implies $\vec{t} = \vec{0}$. It is *repetitive* if for any cluster $P \subset \Lambda$ there exists $R_P > 0$ such that for any $\vec{x} \in \mathbb{R}^d$ the cluster $B_{R_P}(\vec{x}) \cap \Lambda$ contains a cluster which is translation-equivalent to P .

These sets have applications in crystallography (≈ 1920), coding theory, approximation algorithms, and the theory of quasicrystals.

pattern space of a Delone set

Let $\Lambda_0 \subset \mathbb{R}^d$ be a Delone set. The *pattern space (hull)* of Λ_0 is the closure of the set of translates of Λ_0 with respect to the metric ϱ , i.e.

$$\Omega_{\Lambda_0} = \overline{\{\varphi_{\vec{t}}(\Lambda_0) : \vec{t} \in \mathbb{R}^d\}}.$$

Definition

Let $\Lambda_0 \subset \mathbb{R}^d$ be a Delone set and denote by $\varphi_{\vec{t}}(\Lambda_0) = \Lambda_0 - \vec{t}$ its translation by the vector $\vec{t} \in \mathbb{R}^d$. For any two translates Λ_1 and Λ_2 of Λ_0 define $\varrho(\Lambda_1, \Lambda_2) = \inf\{\varepsilon > 0 : \exists \vec{s}, \vec{t} \in B_\varepsilon(\vec{0}) : B_{\frac{1}{\varepsilon}}(\vec{0}) \cap \varphi_{\vec{s}}(\Lambda_1) = B_{\frac{1}{\varepsilon}}(\vec{0}) \cap \varphi_{\vec{t}}(\Lambda_2)\} \wedge 2^{-1/2}$

Assumption

The action of \mathbb{R}^d on Ω is uniquely ergodic:

Ω is a compact metric space with the unique \mathbb{R}^d -invariant probability measure μ .

Theorem

- (i) If $\vec{W} = (\vec{W}_t)_{t \geq 0}$ is the standard Gaussian Brownian motion on \mathbb{R}^d , then for any $\Lambda \in \Omega$ the process $X_t^\Lambda := \varphi_{\vec{W}_t}(\Lambda) = \Lambda - \vec{W}_t$ is a conservative Feller diffusion on (Ω, ϱ) .
- (ii) The semigroup $P_t f(\Lambda) = \mathbb{E}[f(X_t^\Lambda)]$ is self-adjoint on L_μ^2 ,

it is Feller but not strong Feller.

Its associated Dirichlet form is regular, strongly local, irreducible, recurrent, and has Kusuoka-Hino dimension d .

- (iii) The semigroup $(P_t)_{t > 0}$ does not admit heat kernels with respect to μ . It does admit symmetric heat kernels $p_\Omega: (0, \infty) \times \Omega \times \Omega \rightarrow \mathbb{R}$ with respect to the not- σ -finite pushforward measure λ_Ω^d

$$p_\Omega(t, \Lambda_1, \Lambda_2) = \begin{cases} p_{\mathbb{R}^d}(t, h_{\Lambda_1}^{-1}(\Lambda_2)) & \text{if } \Lambda_2 \in \text{orb}(\Lambda_1), \\ 0 & \text{otherwise.} \end{cases} \quad (5)$$

- (iv) There are no semi-bounded or L^p harmonic functions ("Liouville-type").

spectral properties

Theorem

The unitary **Koopman operators** $U_{\bar{t}}$ on $L^2(\Omega, \mu)$ defined by $U_{\bar{t}}f = f \circ \varphi_{\bar{t}}$ commute with the heat semigroup

$$U_{\bar{t}}P_t = P_t U_{\bar{t}}$$

hence commute with the Laplacian Δ , and all spectral operators, such as the unitary Schrödinger semigroup.

... hence **continuous spectrum (no eigenvalues) under natural assumptions even though μ is a probability measure on the compact set Ω .**

Michael Baake and Daniel Lenz, Spectral notions of aperiodic order, Discrete Contin. Dyn. Syst. Ser. S 10 (2017).

Michael Baake, Daniel Lenz, and Aernout van Enter, Dynamical versus diffraction spectrum for structures with finite local complexity, Ergodic Theory Dynam. Systems 35 (2015).

Johannes Kellendonk, Daniel Lenz, and Jean Savinien, Mathematics of aperiodic order, vol. 309, Springer, 2015.

Helmholtz, Hodge and de Rham

Theorem

Assume $d = 1$. Then the space $L^2(\Omega, \mu, \mathbb{R}^d)$ admits the orthogonal decomposition

$$L^2(\Omega, \mu, \mathbb{R}^d) = \text{Im } \nabla \oplus \mathbb{R}(dx). \quad (6)$$

In other words, the L^2 -cohomology is 1-dimensional, which is surprising because the **de Rham cohomology is not one dimensional**.

M. Hinz, M. Röckner, +T., Vector analysis for Dirichlet forms and quasilinear PDE and SPDE on fractals, Stoch. Proc. Appl. (2013).

M. Hinz, +T., Local Dirichlet forms, Hodge theory, and the Navier-Stokes equation on topologically one-dimensional fractals, Trans. Amer. Math. Soc. (2015,2017).

end of the talk :-)

Thank you!